



# Colégio Dinâmico

Educação Infantil - Ensino Fundamental - Ensino Médio



colegiodinamico



colegiodinamicojatai.com.br

ALUNO (A): \_\_\_\_\_ DATA: 08/06/2020

PROFESSORA: \_\_\_\_\_ JARDIM II

## ATIVIDADE

1. CIRCULE A PALAVRA DE ACORDO COM O NOME DE CADA FIGURA.

## LETRA C



COCA  
CUCA  
CACO

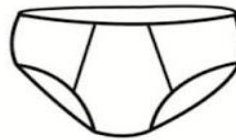

CUCA  
CUIA  
CUECA

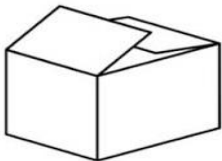

FAIXA  
BAIXA  
CAIXA



CADEADO  
CADEIRA  
CAMELO

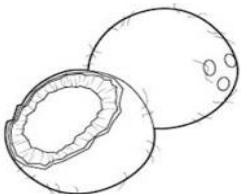

COUVE  
COCO  
COME



CALO  
CABO  
COLA



CAMA  
CAJU  
CASA



CALA  
CAJU  
CAMA

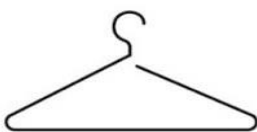

CABIDE  
CABEÇA  
CANETA



COPO  
COCO  
COLA



# Colégio Dinâmico

Educação Infantil - Ensino Fundamental - Ensino Médio



colegiodinamico



colegiodinamicojatai.com.br

ALUNO (A): \_\_\_\_\_ DATA: 08/06/2020

PROFESSORA: \_\_\_\_\_ JARDIM II

Pinte os desenhos que começam com a sílaba destacada.

<b>CA</b>	
<b>CO</b>	
<b>CU</b>	



# Colégio Dinâmico

Educação Infantil - Ensino Fundamental - Ensino Médio



  colegiodinamico  colegiodinamicojatai.com.br

ALUNO (A): \_\_\_\_\_ DATA: 08/06/2020



PROFESSORA: \_\_\_\_\_ JARDIM II

## JUNTANDO TUDO

COMPLETE AS OPERAÇÕES MATEMÁTICAS E EM SEGUIDA PREENCHA A QUANTIDADE DE BOLINHAS CORRESPONDENTE À SOMA:

 +  =



● ● ● ● ● ○ ○ ○ ○ ○

 +  =

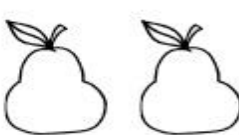
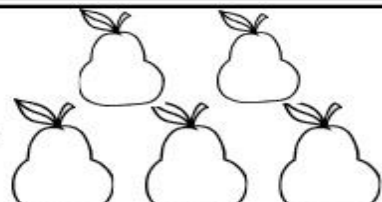
○ ○ ○ ○ ○ ○ ○ ○ ○ ○ ○

 +  =

○ ○ ○ ○ ○ ○ ○ ○ ○ ○ ○

 +  =

○ ○ ○ ○ ○ ○ ○ ○ ○ ○ ○



# Colégio Dinâmico

Educação Infantil - Ensino Fundamental - Ensino Médio



colegiodinamico



colegiodinamicojatai.com.br

ALUNO (A): \_\_\_\_\_ DATA: 09/06/2020.

PROFESSORA: \_\_\_\_\_ JARDIM II

VAMOS LER!

CORRE CUTIA

CORRE CUTIA  
NA CASA DA TIA  
CORRE CIPÓ  
NA CASA DA VÓ  
LENCINHO BRANCO  
CAIU NO CHÃO  
MOÇA BONITA  
DO MEU CORAÇÃO





# Colégio Dinâmico

Educação Infantil - Ensino Fundamental - Ensino Médio

  colegiodinamico  colegiodinamicojatai.com.br

ALUNO (A): \_\_\_\_\_ DATA: 09/06/2020

PROFESSORA: \_\_\_\_\_ JARDIM II

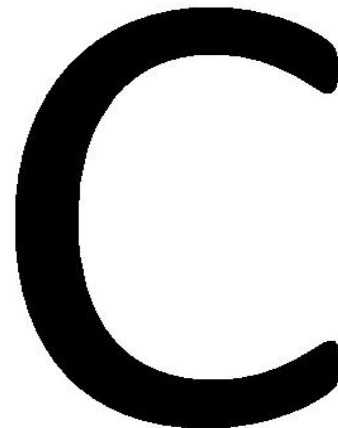

## CUTIA

- \* ESCREVA NOS QUADROS A LETRA C.
- \* ENCONTRE E PINTE AS FIGURAS INICIADAS PELA LETRA C.

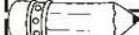
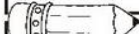

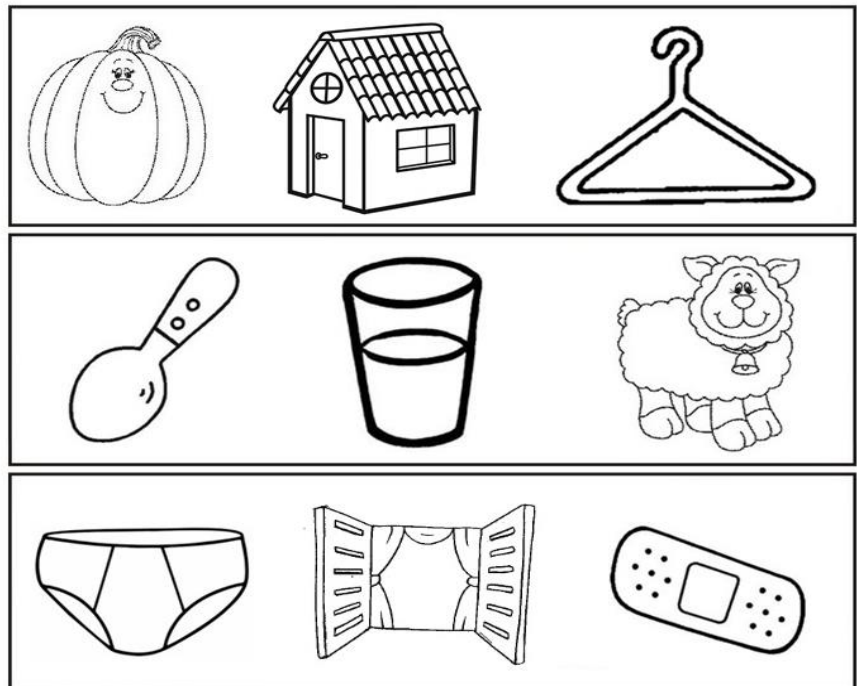

# Colégio Dinâmico

Educação Infantil - Ensino Fundamental - Ensino Médio



colegiodinamico



colegiodinamicojatai.com.br

ALUNO (A): \_\_\_\_\_ DATA: 09/06/2020

PROFESSORA: \_\_\_\_\_ JARDIM II

Vamos ligar os números e colorir o desenho bem bonito!

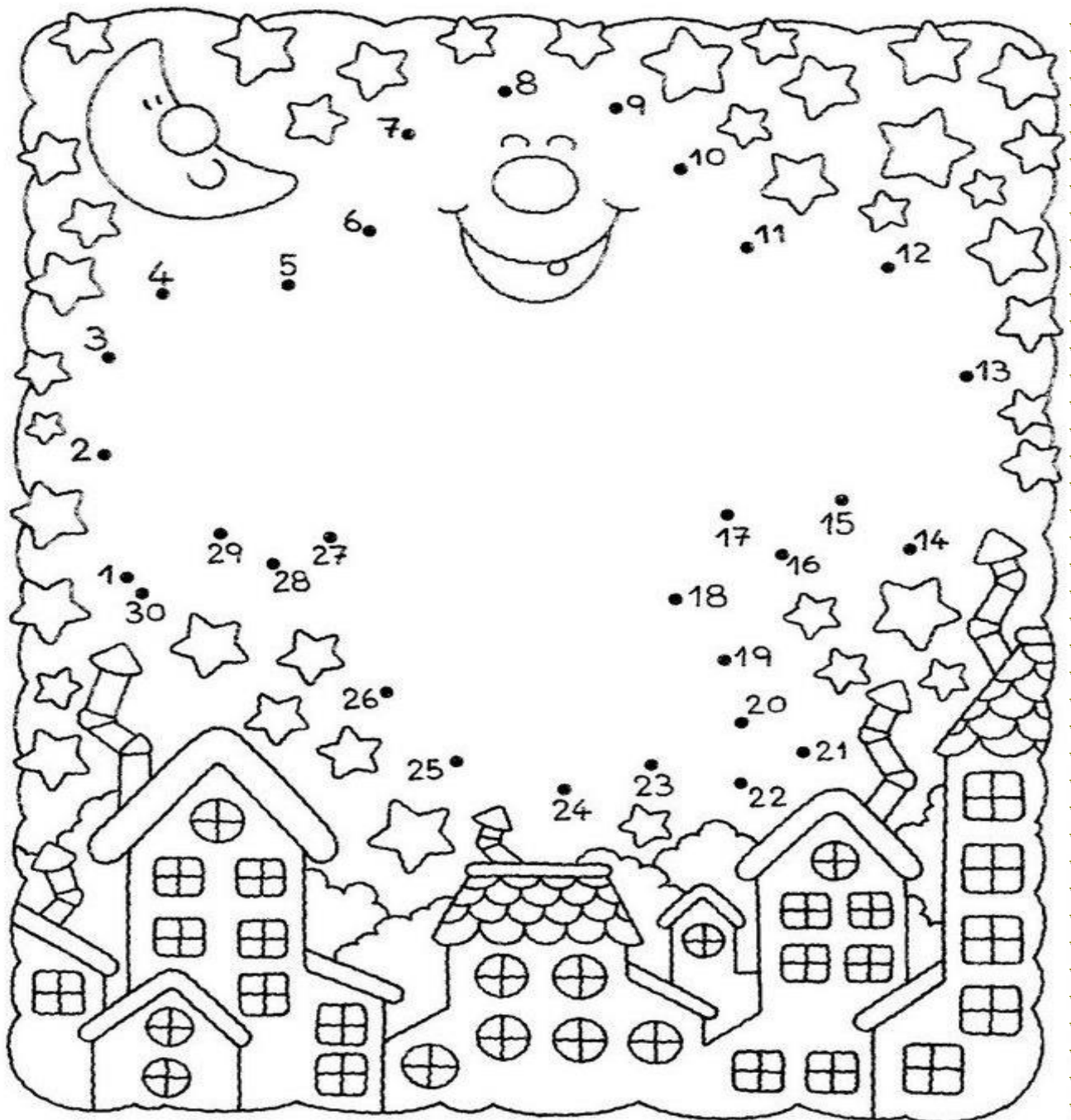



# Colégio Dinâmico

Educação Infantil - Ensino Fundamental - Ensino Médio



colegiodinamico



colegiodinamicojatai.com.br

ALUNO (A): \_\_\_\_\_ DATA: 10/06/2020

PROFESSORA: \_\_\_\_\_ JARDIM II

D Delegado  
d delegado



Repita:

D - D - D - D - D - D - D - D

d - d - d - d - d - d - d - d



# Colégio Dinâmico

Educação Infantil - Ensino Fundamental - Ensino Médio



colegiodinamico



colegiodinamicojatai.com.br

ALUNO (A): \_\_\_\_\_ DATA: 10/06/2020

PROFESSORA: \_\_\_\_\_ JARDIM II



VAMOS COMPLETAR AS PALAVRAS:

DA - DE - DI - DO - DU

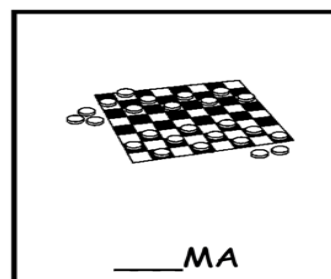
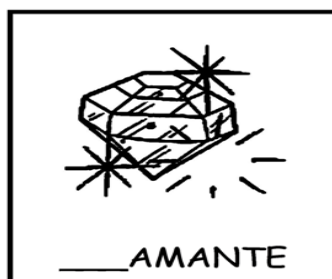
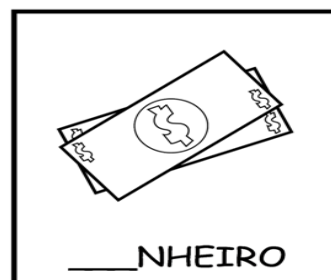
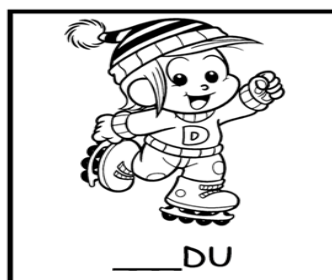
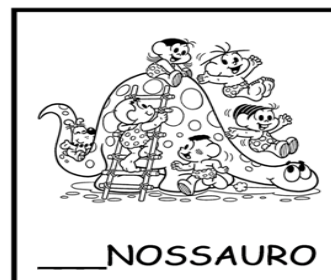
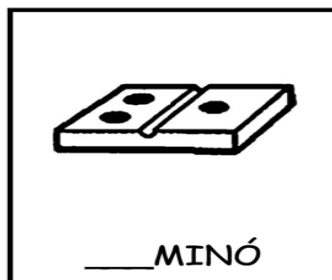
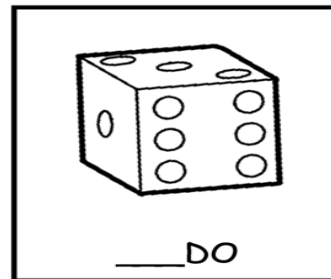
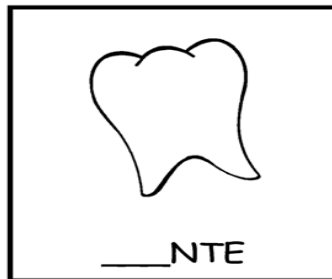
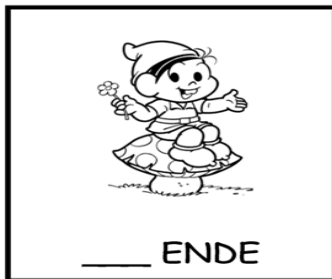





# Colégio Dinâmico

Educação Infantil - Ensino Fundamental - Ensino Médio

  colegiodinamico  colegiodinamicojatai.com.br









































ALUNO (A): \_\_\_\_\_ DATA: 10/06/2020

PROFESSORA: \_\_\_\_\_ JARDIM II

**APROVEITA GENTE QUE O PAGODE É QUENTE  
É FORRÓ PRA TODA ESSA GENTE SE ESPALHAR**



**CONTE E REGISTRE.**

					<input type="text"/>						<input type="text"/>
					<input type="text"/>						<input type="text"/>
					<input type="text"/>						<input type="text"/>
					<input type="text"/>						<input type="text"/>
					<input type="text"/>						<input type="text"/>
					<input type="text"/>						<input type="text"/>